









<p><b>GENERAL DESCRIPTION</b></p>	<p>Door, frame and accessories, 30 min fire resistance and acoustic insulation rating up to 42dB Suitable for installation in places with fire resistance and acoustic insulation requirements.</p>	 <p><b>EI30</b></p> <p>FIRE</p>
<p><b>ACCREDITATION</b></p>	<p>Fire certification as per EN 1634-1 EI30 rating as per EN 13501-2 Acoustic insulation test as per ISO 10140 and rating as per ISO 717-1</p>	 <p><b>ACOUSTIC</b></p>
<p><b>DOOR</b></p>	<p>Rails and stiles in hardwood, edge banded vertical and top of the door Multi-layered acoustic core MDF facing, features as per standard EN 13986 Overall, 57 mm thick with rebate</p>	 <p><b>RW43dB</b></p> <p>DOOR</p>
<p><b>FRAME</b></p>	<p>Jamb in solid wood, 28mm thick, extension in in high density plywood Fixed and adjustable architrave in in high density plywood, features according to EN 13986 Double rebate with compression seals Fire and acoustic seals 15x4mm</p>	 <p><b>RW42dB</b></p> <p>DROP SEAL</p>
<p><b>FINISHES</b></p>	<p>Naturdor® - real wood veneer or stained Dekordor® 3D - embossed finish design vertical or horizontal Dekordor® HD - hard wearing laminate Dekordor® SD - decorative foil Lacdor - Lacquered finish with approximate RAL colour</p>	 <p><b>ANTI SMOKE</b></p> <p>ANTI SMOKE SEAL</p>
<p><b>IRONMONGERY</b></p>	<p>Stainless steel CE marked lock 4" stainless steel CE marked hinges Automatic drop seal</p>	
<p><b>OPTIONS</b></p>	<p>Double leaf available for 41dB acoustic isolation Recessing for electronic lock Concealed door closer or faced mounted Eye viewer Anti smoke seal</p>	
<p><b>ENVIRONMENTAL BENEFITS</b></p>	<p>Recycled content, all series FSC Certified wood, upon request</p>  <p>The mark of responsible forestry</p>	<p><b>ACCREDITATION</b></p>   

Note: Depending on product features or configurations, dimensions will vary. As we are constantly improving our product range, we reserve the right to make changes without prior notice. The guarantee certificate is an integral part of the technical data sheet, available at [www.vicaima.com](http://www.vicaima.com)

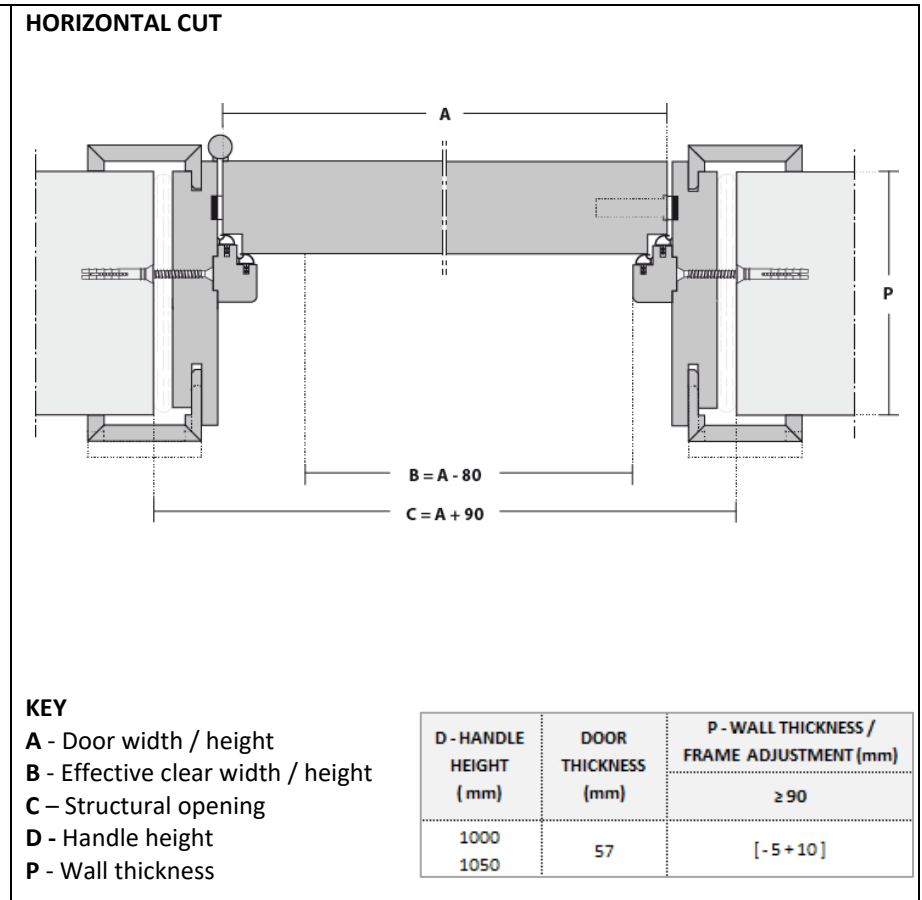
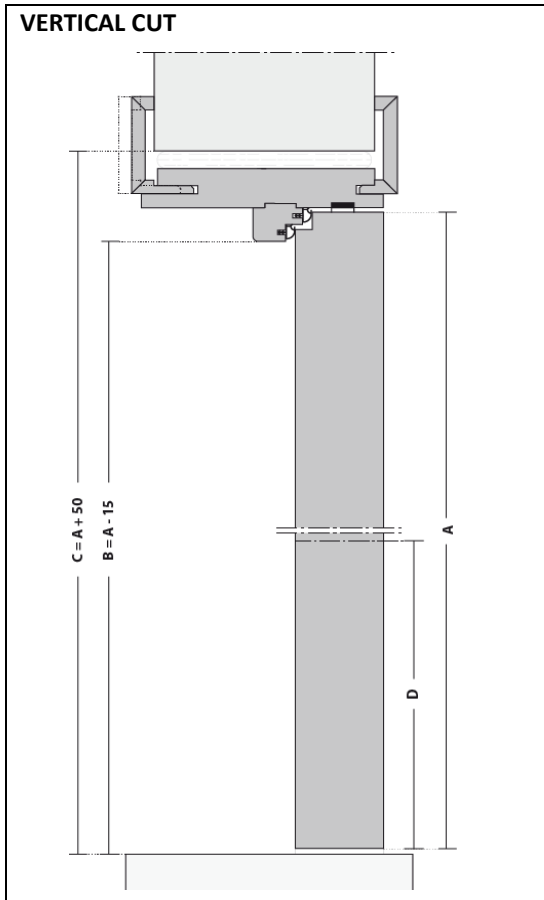

#### KEY

- A - Door width / height
- B - Effective clear width / height
- C - Structural opening
- D - Handle height
- P - Wall thickness

D - HANDLE HEIGHT (mm)	DOOR THICKNESS (mm)	P - WALL THICKNESS / FRAME ADJUSTMENT (mm)
1000	57	≥ 90
1050		[ -5 + 10 ]

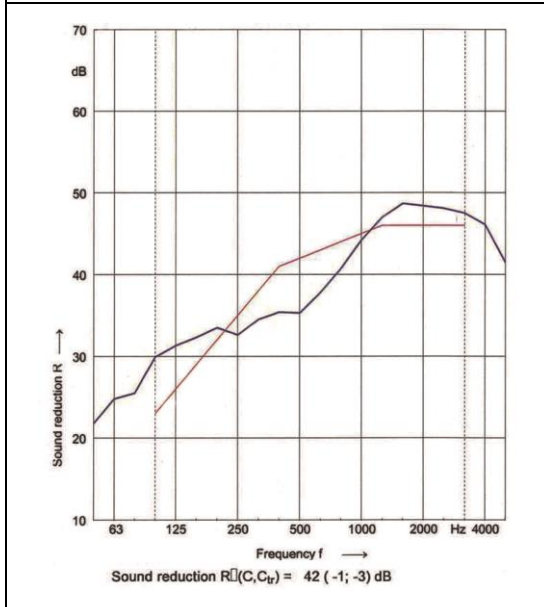

### IRONMONGERY

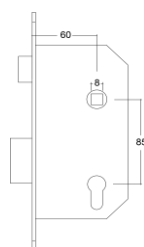

### OPTIONS

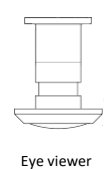
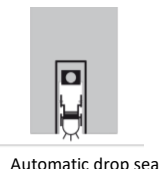
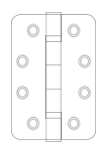
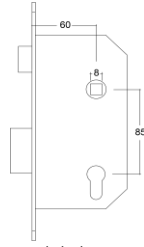

### CONFIGURATIONS

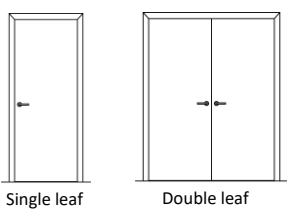

Note: Depending on product features or configurations, dimensions will vary. As we are constantly improving our product range, we reserve the right to make changes without prior notice. The guarantee certificate is an integral part of the technical data sheet, available at [www.vicaima.com](http://www.vicaima.com)